

# EDGE

by hammel



MADE IN  
DENMARK

Vejl. prislise DKK inkl. moms

Ret til ændringer forbeholdes

Gældende pr. 01.07.2022, vers. 1

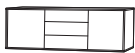

# EDGE

byhammel

Modul	Vangereol		Mål i cm	Sort	Hvid
400		Vangereol basismodul. Leveres inkl.: 2 metalvange, murmontering, beslag til brug for 4 hylde eller til 3 hylde og 1 skab. Højdejusterbar. Tilbehør se side 3.	B: 2,5 H: 210 D: 22 Kg: 5,3 m <sup>3</sup> : 0,013	40 08 0400 2954	40 07 0400 2954
401		Vangereol tilbygningsmodul. Leveres inkl.: 1 metalvange, murmontering, beslag til brug for 4 hylde eller til 3 hylde og 1 skab. Højdejusterbar. Tilbehør se side 3.	B: 2,5 H: 210 D: 22 Kg: 3,3 m <sup>3</sup> : 0,009	40 08 0401 2050	40 07 0401 2050

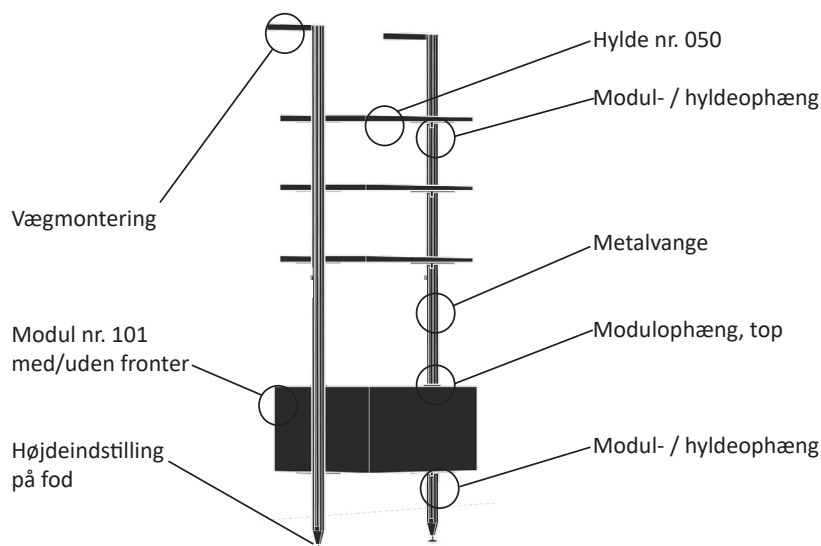

Modul	Vangereol		Mål i cm	Sort	Hvid
420		Til ekstra modul- / hyldeophæng. Pulverlakeret i sort eller hvid.	B: 2,5 H: 4,5 D: 16 Kg: 0,1 m <sup>3</sup> : 0,002	40 08 0420 180	40 07 0420 180
421		Til ekstra modulophæng, top. Til ét ekstra skab skal der bruges 1x420 og 1x421. Pulverlakeret i sort eller hvid.	B: 2 H: 4 D: 5,3 Kg: 0,1 m <sup>3</sup> : 0,001	40 08 0421 148	40 07 0421 148
422		Bøjlestang inkl. 2 afstandsstykker. Total dybde 30cm. Med gummikant for oven. Pulverlakeret i sort eller hvid.	B: 90 H: 3,5 D: 1,2 Kg: 1,4 m <sup>3</sup> : 0,004	40 08 0422 821	40 07 0422 821



1x400\*4x050

1x400\*1x401\*3x050\*4x051  
+1x101\*1x012\*2x0111x400\*1x422\*1x101\*4x011  
+1x050

1x400\*2x401\*10x050\*2x101\*2x012\*4x011

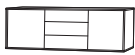

# EDGE















by hammel

Max kg = max anbefalet totalvægt for indhold i og ovenpå væghængt modul.

Vejl. prisliste DKK

Pris gr. 1 (xx)	Pris gr. 2 (xx)	Pris gr. 3 (xx)
81 snehvid	<b>Grundmoduler + hylder:</b> 16 røget eg 75 sort bejdsset <b>Fronter:</b> 15 hvidpig. eg* 16 røget eg 75 sort bejdsset *mat lak	72 sort 82 antracit 95 grafit 98 cappuccino

**Varenr. struktur:**  
EKS: skab nr. 100 i sort:  
40 72 0100

Modul	Moduler til vangereol		Mål i cm	Prisgr.1	Prisgr.2	Prisgr.3
050		5 MAX kg	Hylde til vangereol til 1 sektion. Ved mere end 4 hylder, husk at tilkøbe beslag nr. 420. B: 90,8 H: 1,9 D: 32,5 Kg: 5,0 m <sup>3</sup> : 0,009	40 xx 0050 755	40 xx 0050 985	40 xx 0050 903
051		5 MAX kg	Hylde til vangereol til 1/2 sektion. Ved mere end 4 hylder, husk at tilkøbe beslag nr. 420. B: 46,2 H: 1,9 D: 32,5 Kg: 2,4 m <sup>3</sup> : 0,005	40 xx 0051 427	40 xx 0051 526	40 xx 0051 558
211		20 MAX kg	Skrivepult. Inkl. metalstang, skillerum, hylde, skriveunderlag. Med kabelhul i bunden. Skuffe under klappen. B: 90,8 H: 46,2 D: 32,5 Kg: 30,6 m <sup>3</sup> : 0,213	40 xx 0211 7056	40 xx 0211 8186 Fås i farve 16+75	40 xx 0211 8352
101		40 MAX kg	Skab. Til montering i vangereol. B: 90,8 H: 46,2 D: 32,5 Kg: 18,7 m <sup>3</sup> : 0,213	40 xx 0101 2461	40 xx 0101 2954	40 xx 0101 3019
100		20 MAX kg	Skab. Til montering i vangereol. B: 46,2 H: 46,2 D: 32,5 Kg: 10,8 m <sup>3</sup> : 0,116	40 xx 0100 2133	40 xx 0100 2461	40 xx 0100 2543
102		20 MAX kg	Skab inkl. 1 hylde. Til montering i vangereol. B: 46,2 H: 90,8 D: 32,5 Kg: 18,2 m <sup>3</sup> : 0,215	40 xx 0102 2461	40 xx 0102 2954	40 xx 0102 3019
010		5 MAX kg	Hylde til modul 100 + 101 + 102. B: 42,3 H: 1,7 D: 28,05 Kg: 1,5 m <sup>3</sup> : 0,004	40 xx 0010 327	40 xx 0010 393	40 xx 0010 409
011		10 MAX kg	Skuffe til modul 100 + 101 + 102. Med pushåbning og fuldt udtræk. B: 44,4 H: 22 D: 26,7 Kg: 5,1 m <sup>3</sup> : 0,057	40 xx 0011 1623	40 xx 0011 1705	40 xx 0011 1723
012			Dør til modul 100 + 101 + 102. Med pushåbning. B: 44,4 H: 44,4 D: 1,7 Kg: 2,8 m <sup>3</sup> : 0,011	40 xx 0012 738	40 xx 0012 1067	40 xx 0012 1148
013			Høj dør til 102. Med pushåbning. B: 89,2 H: 44,4 D: 1,7 Kg: 5,2 m <sup>3</sup> : 0,022	40 xx 0013 985	40 xx 0013 1231	40 xx 0013 1296
021			Lav klap til 101. Med pushåbning. B: 89,2 H: 22 D: 1,7 Kg: 3,0 m <sup>3</sup> : 0,013	40 xx 0021 1476	40 xx 0021 1805	40 xx 0021 1887
014			Høj klap til 101. Med pushåbning. B: 89,2 H: 44,4 D: 1,7 Kg: 5,6 m <sup>3</sup> : 0,022	40 xx 0014 1805	40 xx 0014 2133	40 xx 0014 2215
022 023 035			Lav stofklap til 101. Med pushåbning. B: 89,2 H: 22,0 D: 1,7 Kg: 2,1 m <sup>3</sup> : 0,013	40 05 0022 2133 sort	40 05 0023 2543 grafit	40 05 0035 2543 hvid
015 016 036			Høj stofklap til 101. Med pushåbning. B: 89,2 H: 44,4 D: 1,7 Kg: 3,1 m <sup>3</sup> : 0,022	40 05 0015 2297 sort	40 05 0016 3035 grafit	40 05 0036 3035 hvid



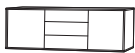

# EDGE















by hammel

Max kg = max anbefalet totalvægt for indhold i og ovenpå væghængt modul.

Vejl. prisliste DKK

Pris gr. 1 (xx)	Pris gr. 2 (xx)	Pris gr. 3 (xx)
81 snehvid	Grundmoduler + hylder: 16 røget eg 75 sort bejdset Fronter: 15 hvidpig. eg* 16 røget eg 75 sort bejdset *mat lak	72 sort 82 antracit 95 grafit 98 cappuccino

Varenr. struktur:  
EKS: skab nr. 100 i sort:  
40 72 0100

Modul	Grundmoduler D: 32,5 cm	Mål i cm	Prisgr.1	Prisgr.2	Prisgr.3
100	 20 MAX kg Skab. Ved ben: anvend min. 4 stk.	B: 46,2 H: 46,2 D: 32,5 Kg: 10,8 m <sup>3</sup> : 0,116	40 xx 0100 2133	40 xx 0100 2461	40 xx 0100 2543
101	 40 MAX kg Skab. Ved ben: anvend min. 4 stk.	B: 90,8 H: 46,2 D: 32,5 Kg: 18,7 m <sup>3</sup> : 0,213	40 xx 0101 2461	40 xx 0101 2954	40 xx 0101 3019
211	 20 MAX kg Skrivepult. Inkl. metalstang, skillerum, hylde, skriveunderlag. Med kabelhul i bunden. Skuffe under klappen.	B: 90,8 H: 46,2 D: 32,5 Kg: 30,6 m <sup>3</sup> : 0,213	40 xx 0211 7056	40 xx 0211 8186 Fås i farve 16+75	40 xx 0211 8352
102	 20 MAX kg Skab inkl. 1 hylde. Ved ben: anvend min. 4 stk.	B: 46,2 H: 90,8 D: 32,5 Kg: 18,2 m <sup>3</sup> : 0,215	40 xx 0102 2461	40 xx 0102 2954	40 xx 0102 3019
103	 40 MAX kg Skab inkl. 2 hylder. Ved ben: anvend min. 4 stk.	B: 90,8 H: 90,8 D: 32,5 Kg: 30,0 m <sup>3</sup> : 0,394	40 xx 0103 2954	40 xx 0103 3775	40 xx 0103 3856
052	 Bagklædning til skab 103. Inkl. monteringsbeslag. Så modulet kan anvendes fritstående.	B: 90,3 H: 90,3 D: 1,2 Kg: 8,2 m <sup>3</sup> : 0,024	40 xx 0052 1412		40 xx 0052 1558
Modul	Tilbehør til D: 32,5	Mål i cm	Prisgr.1	Prisgr.2	Prisgr.3
010	 5 MAX kg Hylde til modul 100 + 101 + 102 + 103.	B: 42,3 H: 1,7 D: 28,05 Kg: 1,5 m <sup>3</sup> : 0,004	40 xx 0010 327	40 xx 0010 393	40 xx 0010 409
011	 10 MAX kg Skuffe til modul 100 + 101 + 102 + 103. Med pushåbning og fuldt udtræk.	B: 44,4 H: 22 D: 26,7 Kg: 5,1 m <sup>3</sup> : 0,057	40 xx 0011 1623	40 xx 0011 1705	40 xx 0011 1723
012	 Dør til modul 100 + 101 + 102 + 103. Med pushåbning.	B: 44,4 H: 44,4 D: 1,7 Kg: 2,8 m <sup>3</sup> : 0,011	40 xx 0012 738	40 xx 0012 1067	40 xx 0012 1148
013	 Høj dør til 102 + 103. Med pushåbning.	B: 89,2 H: 44,4 D: 1,7 Kg: 5,2 m <sup>3</sup> : 0,022	40 xx 0013 985	40 xx 0013 1231	40 xx 0013 1296
021	 Lav klap til 101 + 103. Med pushåbning.	B: 89,2 H: 22,0 D: 1,7 Kg: 3,0 m <sup>3</sup> : 0,013	40 xx 0021 1476	40 xx 0021 1805	40 xx 0021 1887
014	 Høj klap til 101 + 103 Med pushåbning. 103: For montering i bund, monteres push-beslag i siden af modulet.	B: 89,2 H: 44,4 D: 1,7 Kg: 5,6 m <sup>3</sup> : 0,022	40 xx 0014 1805	40 xx 0014 2133	40 xx 0014 2215
022 023 035	 Lav stofklap til 101 + 103. Med pushåbning.	B: 89,2 H: 22,0 D: 1,7 Kg: 2,1 m <sup>3</sup> : 0,013	40 05 0022 2133 sort	40 05 0023 2543 grafit	40 05 0035 2543 hvid
015 016 036	 Høj stofklap til 101 + 103. Med pushåbning. 103: For montering i bund, monteres push-beslag i siden af modulet.	B: 89,2 H: 44,4 D: 1,7 Kg: 3,1 m <sup>3</sup> : 0,022	40 05 0015 2297 sort	40 05 0016 3035 grafit	40 05 0036 3035 hvid

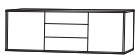

# EDGE











by hammel

Max kg = max anbefalet totalvægt for indhold i og ovenpå væghængt modul.

Vejl. prisliste DKK

Pris gr. 1 (xx)	Pris gr. 2 (xx)	Pris gr. 3 (xx)
81 snehvid	Grundmoduler + hylder: 16 røget eg 75 sort bejdet Fronter: 15 hvidpigm. eg* 16 røget eg 75 sort bejdet *mat lak	72 sort 82 antracit 95 grafit 98 cappuccino

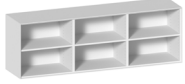
Varenr. struktur:  
EKS: skab nr. 100 i sort:  
40 72 0100

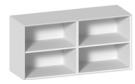
Modul	Grundmoduler D: 42 cm	Mål i cm	Prisgr.1	Prisgr.2	Prisgr.3
104	 40 MAX kg	Skab, inkl. 2 hylder. Ved ben: anvend min. 4 stk. B: 90,8 H: 90,8 D: 42 Kg: 37,7 m <sup>3</sup> : 0,492	40 xx 0104 3608	40 xx 0104 4266	40 xx 0104 4429
052		Bagklædning til skab 104. Inkl. monteringsbeslag. Så skabet kan anvendes fritstående. B: 90,3 H: 1,2 D: 90,3 Kg: 8,2 m <sup>3</sup> : 0,024	40 xx 0052 1412		40 xx 0052 1558
207	 20 MAX kg	AV modul. Ledningshul i top og bund. Inkl. dæksel. Væghænges gennem bagklædning. Ved ben: anvend min. 5 stk. B: 90,8 H: 24,0 D: 42 Kg: 17,5 m <sup>3</sup> : 0,152	40 xx 0207 2954	40 xx 0207 3346	40 xx 0207 3478
208	 20 MAX kg	AV modul. Ledningshul i top og bund. Inkl. dæksel. Ved ben: anvend min. 5 stk. B: 90,8 H: 46,2 D: 42 Kg: 21,0 m <sup>3</sup> : 0,261	40 xx 0208 3019	40 xx 0208 3445	40 xx 0208 3527
203	 20 MAX kg	Skab. Ved ben: anvend min. 5 stk. B: 180,4 H: 46,2 D: 42 Kg: 45,7 m <sup>3</sup> : 0,502	40 xx 0203 4594	40 xx 0203 5578	40 xx 0203 5660
204	 20 MAX kg	AV modul. Ledningshul i top og bund. Inkl. dæksel. Ved ben: anvend min. 5 stk. B: 180,4 H: 46,2 D: 42 Kg: 45,7 m <sup>3</sup> : 0,502	40 xx 0204 4922	40 xx 0204 5907	40 xx 0204 5989
205	 20 MAX kg	Skab. Væghænges gennem bagklædning. Ved ben: anvend min. 4 stk. B: 180,4 H: 24 D: 42 Kg: 32,9 m <sup>3</sup> : 0,292	40 xx 0205 4266	40 xx 0205 5250	40 xx 0205 5332
206	 20 MAX kg	AV modul. Ledningshul i top og bund. Inkl. dæksel. Væghænges gennem bagklædning. Ved ben: anvend min. 4 stk. B: 180,4 H: 24,0 D: 42 Kg: 32,9 m <sup>3</sup> : 0,292	40 xx 0206 4594	40 xx 0206 5578	40 xx 0206 5660
212	 100 MAX kg	AV modul. Ledningshul i top og bund. Inkl. dæksel. NB! Kan IKKE væghænges. <b>Anvend min. 6 ben eller sokkel.</b> B: 225,8 H: 46,2 D: 42 Kg: 47,8 m <sup>3</sup> : 0,626	40 xx 0212 5913		40 xx 0212 7285
500	 40 MAX kg	Skab inkl. 3 hylder. Ved ben: anvend min. 6 stk. B: 179,9 H: 59,0 D: 42 Kg: 51,8 m <sup>3</sup> : 0,535	40 xx 0500 5250	40 xx 0500 6562	40 xx 0500 6645
053		Bagklædning til skab 500. Inkl. monteringsbeslag. Så skabet kan anvendes fritstående. B: 179,2 H: 58,3 D: 1,2 Kg: 10,5 m <sup>3</sup> : 0,030	40 xx 0053 1576		40 xx 0053 1723
501	 20 MAX kg	Skab inkl. 2 hylder. Ved ben: anvend min. 5 stk. B: 120,4 H: 59,0 D: 42 Kg: 31,8 m <sup>3</sup> : 0,428	40 xx 0501 4348	40 xx 0501 5660	40 xx 0501 5742

## h ammell tegneprogram

Prøv tegneprogrammet fra Hammel. Her kan du nemt designe din egen opstilling på tablet, mobil eller computer.

Find link til tegneprogrammet på:  
[www.hammel-furniture.dk/tegneprogram.aspx](http://www.hammel-furniture.dk/tegneprogram.aspx)  
Eller download vores app: Hammel

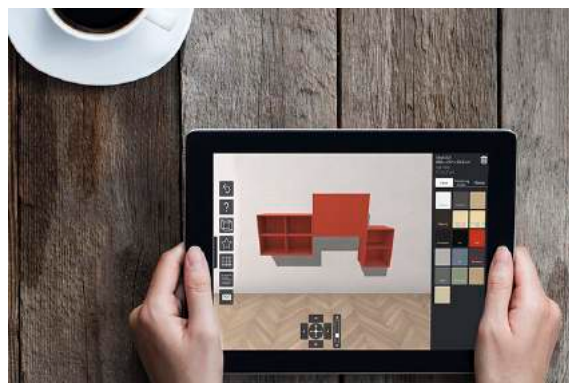

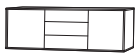

# EDGE















by hammel









Max kg = max anbefalet totalvægt for indhold i og ovenpå væghængt modul.

Vejl. prisliste DKK

Pris gr. 1 (xx)	Pris gr. 2 (xx)	Pris gr. 3 (xx)
81 snehvid	<b>Grundmoduler + hylder:</b> 16 røget eg 75 sort bejdet	72 sort 82 antracit 95 grafit 98 cappuccino
	<b>Fronter:</b> 15 hvidpigment. eg* 16 røget eg 75 sort bejdet *mat lak	

Varenr. struktur:  
EKS: skab nr. 100 i sort:  
40 72 0100

Modul	Tilbehør til D: 42		Mål i cm	Prisgr.1	Prisgr.2	Prisgr.3
033		5 MAX kg	Hylde til modul 104 + 212. B: 42,3 H: 1,7 D: 37,65 Kg: 2,1 m³: 0,006	40 xx 0033 361	40 xx 0033 427	40 xx 0033 460
019		5 MAX kg	Hylde til modul 203 + 204 + 205 + 206 + 207 + 208 + 212. B: 87,1 H: 1,7 D: 37,65 Kg: 4,0 m³: 0,009	40 xx 0019 656	40 xx 0019 755	40 xx 0019 770
031		5 MAX kg	Hylde til modul 500 + 501. B: 57,0 H: 1,7 D: 37,65 Kg: 2,9 m³: 0,006	40 xx 0031 656	40 xx 0031 755	40 xx 0031 770
032		10 MAX kg	Skuffe til modul 104 + 212. Med pushåbning og med fuldt udtræk. B: 44,4 H: 22 D: 36,7 Kg: 5,9 m³: 0,072	40 xx 0032 1705	40 xx 0032 1788	40 xx 0032 1821
020		10 MAX kg	Skuffe til modul 203 + 204 + 205 + 206 + 207 + 208 + 212. Med pushåbning og med fuldt udtræk. B: 89,6 H: 22,0 D: 36,7 Kg: 8,9 m³: 0,136	40 xx 0020 1805	40 xx 0020 1953	40 xx 0020 1968
024		10 MAX kg	Skuffe til modul 500 + 501. Med pushåbning og med fuldt udtræk. B: 59,1 H: 18,8 D: 36,7 Kg: 6,2 m³: 0,082	40 xx 0024 1623	40 xx 0024 1705	40 xx 0024 1723
012			Dør til modul 104 + 212. Med pushåbning. B: 44,4 H: 44,4 D: 1,7 Kg: 2,8 m³: 0,011	40 xx 0012 738	40 xx 0012 1067	40 xx 0012 1148
013			Høj dør til 104. Med pushåbning. B: 89,2 H: 44,4 D: 1,7 Kg: 5,2 m³: 0,022	40 xx 0013 985	40 xx 0013 1231	40 xx 0013 1296
025			Dør til 500 + 501. Med pushåbning. B: 59,1 H: 57,1 D: 1,7 Kg: 4,4 m³: 0,018	40 xx 0025 985	40 xx 0025 1231	40 xx 0025 1296
026 027 037			Stof dør til 500 + 501. Med pushåbning. B: 59,1 H: 57,1 D: 1,7 Kg: 2,1 m³: 0,018	40 05 0026 1591 sort	40 05 0027 2083 grafit	40 05 0037 2083 hvid
021			Lav klap til 104 + 203 + 204 + 205 + 206 + 207 + 208 + 212. Med pushåbning. B: 89,2 H: 22,0 D: 1,7 Kg: 3,0 m³: 0,013	40 xx 0021 1476	40 xx 0021 1805	40 xx 0021 1887
014			Høj klap til 104 + 203 + 204 + 208 + 212. Med pushåbning. B: 89,2 H: 44,4 D: 1,7 Kg: 5,6 m³: 0,022	40 xx 0014 1805	40 xx 0014 2133	40 xx 0014 2215
022 023 035			Lav stofklap til modul 104+203+204 + 205+206+207+208+212. Med pushåbning. B: 89,2 H: 22,0 D: 1,7 Kg: 2,1 m³: 0,013	40 05 0022 2133 sort	40 05 0023 2543 grafit	40 05 0035 2543 hvid
015 016 036			Høj stofklap til 104 + 203 + 204 + 208+212. Med pushåbning. B: 89,2 H: 44,4 D: 1,7 Kg: 3,1 m³: 0,022	40 05 0015 2297 sort	40 05 0016 3035 grafit	40 05 0036 3035 hvid

Modul	Hjul og ben		Mål i cm		
177		Stillefødder, 6 stk. Kan monteres under alle grundmoduler.	B: 2,8 H: 2,1-2,5 D: 2,8 Kg: 0,2 m <sup>3</sup> : 0,001	10 20 0177	303
187		Rustik hjul, 6 stk. heraf 2 stk. med bremser. Kan monteres under alle grundmoduler.	B: 3,5 H: 12,0 D: 10,5 Kg: 2,3 m <sup>3</sup> : 0,008	10 20 0187	937
174 176		Metalben, 4 stk. Kan monteres under alle grundmoduler. Husk støtteben 198/199 ved moduler med en bredde på mere end 91 cm.	B: 22,0 H: 20,0 D: 2,0 Kg: 2,1 m <sup>3</sup> : 0,011	10 20 0174	10 20 0176 1076 sort 1076 hvid
198 199		Støtteben, 1 stk. Til brug ved moduler over 91 cm. Kan justeres fra 14- 20 cm.	B: 2,0 H: 20,0 D: 2,0 Kg: 0,4 m <sup>3</sup> : 0,009	10 20 0198	10 20 0199 179 sort 179 hvid
256		Metal sokkel til skab nr. 104. Fås i hvid og sort pulverlak.	B: 86,0 H: 30,0 D: 38,5 Kg: 3,8 m <sup>3</sup> : 0,009	40 08 0256	40 07 0256 865 sort 865 hvid
257		Metal sokkel til skab nr. 500+205+206+203+204. Fås i hvid og sort pulverlak.	B: 176,0 H: 30,0 D: 38,5 Kg: 5,3 m <sup>3</sup> : 0,017	40 08 0257	40 07 0257 1153 sort 1153 hvid
Modul	Væghylde		Mål i cm		
450 452	 5 MAX kg	Metal hylde. Pulverlakeret i sort eller hvid.	B: 65,0 H: 18,9 D: 27,0 Kg: 2,7 m <sup>3</sup> : 0,007	10 20 0450	10 20 0452 903 sort 903 hvid
451 453	 5 MAX kg	Metal hylde. Pulverlakeret i sort eller hvid.	B: 65,0 H: 13,1 D: 17,0 Kg: 2,0 m <sup>3</sup> : 0,007	10 20 0451	10 20 0453 837 sort 837 hvid

Få yderligere information i vores Edge by Hammel brochure.  
Her finder du inspiration til spændende Edge by Hammel løsninger.

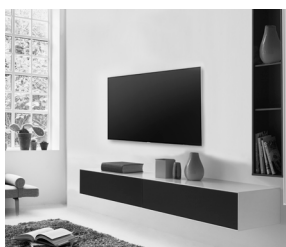

Se disse og flere opstillinger i vores tegneprogram under  Galleri.



**hammel**<sup>®</sup>  
*harmony in the making*

Hammel Furniture A/S - Anbækvej 111 - DK- 8450 Hammel - sales@hammel-furniture.dk  
www.hammel-furniture.dk - facebook.com/byhammel - instagram @byhammel